

WWW.EYYES.COM

# CAREYE® SAFETY ANGLE TURN-ASSIST



## INSTALLATION AND INSTRUCTION MANUAL CENTRAL CONTROL BOX AND CAMERAS



Document: **S06-010\_402\_EN CarEye Safety Angle Teil M**  
Version: **4.0.2**  
Article: **BT-DOC-00181**

---

**EYYES GmbH**

Im Wirtschaftspark 4  
3494 Gedersdorf  
Österreich

office@eyyes.com  
www.eyyes.com

## ■ CONTENTS

GENERAL NOTES .....	03
SAFETY INSTRUCTIONS .....	04
Important documents.....	08
Function description and function modules.....	12
Field of application .....	14
Components - overview .....	20
Components - TIC Box.....	21
Components - TIC Box TATIC-S.....	22
Components - cameras.....	24
Components - signal element.....	26
Components - Monitors .....	27
Optional - STEERING ANGLE SENSOR.....	28
Mounting - Camera Wing.....	32
Mounting - TIC Box.....	38
Mounting - Signal element.....	39
Mounting - monitor.....	40
Installation - optional Steering angle sensor.....	41
Electrical connection.....	44
Optional Steering angle sensor: Initial commissioning .....	58
Configuration .....	63
Operation and use.....	68
System check and troubleshooting.....	73
Parts overview .....	74
General information.....	82

## CAREYE® SAFETY ANGLE - TURN-ASSIST INSTALLATION AND INSTRUCTION MANUAL

### ■ GENERAL NOTES

**Read this manual carefully, it contains important information and notes on assembly, commissioning and safe operation.**

**Pay particular attention to the following markings:**



Information that serves the proper operation and handling is shown with this symbol. Non-observance may lead to damage or functional restrictions.



Warnings are information that is of particular importance for proper operation and safe handling. These are shown with this symbol.



Hazards that may expose the user to particular danger are indicated with this symbol.

## CAREYE® SAFETY ANGLE - TURN-ASSIST INSTALLATION AND INSTRUCTION MANUAL

### ■ SAFETY INSTRUCTIONS

#### ABOUT CAREYE® SAFETY ANGLE



- The CAREYE® SAFETY ANGLE system is an assistance system to support the driver. The responsibility for monitoring remains with the driver.
- CAREYE® SAFETY ANGLE is not a direct replacement for the rear-view or exterior mirror system and, due to the variety of situations in road traffic, cannot provide any guarantee regarding the detection rate or error detection rate in operation.
- CAREYE® SAFETY ANGLE is a driving assistance system and therefore serves to support the driver, but in no way represents an automation system. CAREYE® SAFETY ANGLE is designed as a retrofit device for actively warning the driver of potentially dangerous situations. The detection and false alarm rates of the system depend on the installation and the current environmental conditions. No warranty is given by the manufacturer for the situation-related detection or the analysis behavior of the "artificial intelligence" used in the CAREYE® SAFETY ANGLE.
- All components are intended exclusively for the intended use.

## CAREYE® SAFETY ANGLE - TURN-ASSIST INSTALLATION AND INSTRUCTION MANUAL

### ■ Safety Instructions

#### INSTALLATION



- Installation must be carried out by registered workshops for motor vehicles or commercial vehicles or by authorized workshops, otherwise warranty claims will become void.
- Only install and operate the TIC box, the monitors and the signal elements in a dry and dust-free environment, away from impact areas or the deployment area of an airbag.
- Take care not to damage any important parts or injure any cables or hoses during installation preparations (e.g. drilling holes) and installation.
- The operating temperature is between -20°C and +70°C, the humidity between 20% and 80% (non-condensing).
- Mount the devices securely and tightly according to the section "Mounting". Remove any protective films before commissioning.
- Connect all components only to the vehicle's electrical system with a nominal voltage of 12 to 24 VDC. Ensure the correct polarity of the supply voltage.
- Manual control devices, indicator lamps and displays in the passenger compartment must not be covered by the monitor and signal transmitter.
- During all activities, ensure your personal safety, the safe use of tools and aids, and the securing of the vehicle.

## ■ Safety Instructions

### OPERATION



- Operate the components only on the vehicle electrical system with 12 to 24 VDC nominal voltage of the vehicle.
- Observe the mechanical, electrical and climatic operating conditions.
- Do not use the devices if they show visible damage.
- Protect the cables from heat, sharp edges and aggressive substances such as oils or fuels.
- Do not extend cable connections independently, individual cable sets are available on request.
- Keep the components away from strong electric and magnetic fields.
- Do not use any components other than those supplied, do not plug in any third-party devices.
- Do not glue parts at the components, the solvent could damage the surfaces.
- Make sure that the viewing glasses of the camera(s) are clean and free from scratches, cracks or stone chips. The functioning of the entire system is largely dependent on the quality of the camera images. In the event of a defect or if the viewing glass is cloudy, for example, the camera must be replaced.
- Interrupt the power supply immediately if liquids or foreign bodies have penetrated the devices.
- Do not use the devices in areas with a high risk of explosion.

## CAREYE® SAFETY ANGLE - TURN-ASSIST INSTALLATION AND INSTRUCTION MANUAL

### ■ Safety Instructions

#### CLEANING AND MAINTENANCE



- The camera(s) are splash-proof - but avoid spraying them directly with a high-pressure cleaner.
- Replace defective, damaged or kinked cables immediately.
- Do not attempt to service the product yourself, as opening it may expose you to dangerous electrical voltages or other hazards.  
Opening the equipment will void the warranty.
- Regularly check the functions and condition of the components of the turn assistant.  
In the event of defects, recognizable damage or wear, the product can no longer be used or used safely. Have it repaired immediately.
- Clean the monitors and the signal elements only with a soft, clean and dry cloth. Never use solvents, oils or other cleaning agents.
- Disconnect the power supply during cleaning or maintenance activities.
- Use only original spare parts and have repairs carried out only in specialist workshops authorized by EYYES.
- EYYES accepts no liability for damage caused by failure to observe this manual. This manual is part of the product.

# CAREYE® SAFETY ANGLE - TURN-ASSIST INSTALLATION AND INSTRUCTION MANUAL

## ■ IMPORTANT DOCUMENTS

The following documents are important components of the products, which must be observed accordingly.

<b>DOCUMENT</b>	Installation and Instruction Manual Control Box and Cameras <b>(Part M)</b>
<b>CONTENT</b>	<ul style="list-style-type: none"> <li>■ Safety instructions</li> <li>■ Function descriptions</li> <li>■ Component description</li> <li>■ Assembly</li> <li>■ Connection</li> <li>■ Configuration</li> <li>■ Operation and use</li> <li>■ System check</li> <li>■ Parts overview</li> </ul>
<b>ENCLOSED</b>	SET TIC Box TATIC
<b>NOTES</b>	Carry in the vehicle required



<b>DOCUMENT</b>	Drilling template
<b>CONTENT</b>	Drilling template for the camera base
<b>ENCLOSED</b>	Camera TACAM
<b>NOTES</b>	---

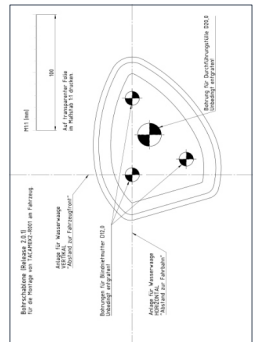

# CAREYE® SAFETY ANGLE - TURN-ASSIST INSTALLATION AND INSTRUCTION MANUAL

## ■ Important documents

<b>DOCUMENT</b>	Installation manual Monitor 10 oder 12“ <b>(Part D)</b>
<b>CONTENT</b>	<ul style="list-style-type: none"> <li>■ Safety instructions</li> <li>■ Function descriptions</li> <li>■ Component description</li> <li>■ Installation</li> <li>■ Connection</li> <li>■ Commissioning</li> <li>■ Parts overview</li> </ul>
<b>ENCLOSED</b>	Monitor TAMON
<b>NOTES</b>	Carry in the vehicle not required



<b>DOCUMENT</b>	CarEye Safety Angle General operating permit
<b>CONTENT</b>	ABE and field of applicatio
<b>ENCLOSED</b>	SET TIC Box TATIC
<b>NOTES</b>	Carry in the vehicle not required







## ■ FUNCTION DESCRIPTION AND FUNCTION MODULES

As part of the CAREYE® product suite, the TASET002 variant offers a flexible, expandable and safe system for use as an TURN-ASSIST / BLIND SPOT ASSISTANT with proven safety functions. The TURN ASSIST is suitable as a retrofit solution or for equipping new vehicles. In particular, it can be used for commercial vehicles, buses or special and emergency vehicles.

TASET002 CAREYE® SAFETY ANGLE detects people and cyclists on the basis of artificial intelligence and reliably informs the driver in real time. Thanks to a signaling strategy specially developed by EYYES, the system is able to distinguish between "information" and "warning". Objects that are not relevant are recognized as such and included in the evaluation, thus reducing warnings to the lowest possible level.

The basic version of CAREYE® SAFETY ANGLE as an TURN ASSIST consists of the central interface and controller box (TIC box), the signal element and one (or 2) digital camera sensors. The TIC box processes these camera signals, detects and classifies objects and provides the necessary interfaces for connection to the vehicle electronics. Due to its compact design, the TIC box can be easily mounted indoors. The cameras are installed in suitable positions on the outside of the vehicle. The heated cameras are available as a compact surface-mounted version or as a stable camera arm. Thanks to its ergonomic and safe design, this camera arm enables optimum observation of what is happening along the vehicle - even with bodies wider than the driver's cab - and of the blind spot.



## CAREYE® SAFETY ANGLE - TURN-ASSIST INSTALLATION AND INSTRUCTION MANUAL

### ■ Function description and function modules

If a person or a cyclist is detected in the danger zone when turning, the driver is warned by the optical signal indicator and additionally with a loud sound generator.

The system activates automatically by evaluating the speed of the vehicle, the activated direction indicator and the steering angle. There is no warning when the hazard warning lights are used.

Optionally, light-intensive displays with different diagonals can be used to additionally display the camera images including the detected objects and persons in the danger zone.

Furthermore, the TIC box can be the future-proof central control unit for additional safety and comfort functions available to the drivers:

- the rear view camera with automatic activation as a rear view assistant



## CAREYE® SAFETY ANGLE - TURN-ASSIST INSTALLATION AND INSTRUCTION MANUAL

### ■ FIELD OF APPLICATION

The TASET002 CAREYE® SAFETY ANGLE turn-off assistant is designed for all commercial vehicles of classes N2 and N3 and for all buses of classes M2 and M3 with more than nine seats including the driver's seat including the driver's seat.

The basic function of the TURN ASSIST with integrated artificial intelligence, can be performed by connecting the TIC BOX to the power supply and correct mounting of the "Wing" or the signal transmitter on the A-pillar.

The system must be completely installed on the vehicle in which the driver contains the warning. In addition to the installation instructions the following installation conditions in particular must be observed.



#### **Advanced collision warning by motion prediction:**

To use the advanced collision warning by motion prediction function of the TASET002, the connection to the CAN bus for the speed signal and the steering angle is required. In addition, the turn signal can be tapped via the GPIO connectors. Optionally, it is possible to retrofit a steering angle sensor for vehicles with a vertical steering column lever.



## CAREYE® SAFETY ANGLE - TURN-ASSIST INSTALLATION AND INSTRUCTION MANUAL

### ■ Field of application



The Wing type camera must be

- at a mounting height of between 2,300 and 3,800 mm,
- at a mounting distance from the front of the vehicle of between 1,200 and 1,800 mm

be mounted on the passenger compartment or on the body of the vehicle.

It must be ensured that

- the Wing is horizontal to the ground,
- the wing is aligned at 90° to the vehicle axis,
- the mounting position is on as level a surface as possible.

Please ensure that the Wing does not impair direct or indirect vision and that the function of any existing sensors or elements is not impaired.



## CAREYE® SAFETY ANGLE - TURN-ASSIST INSTALLATION AND INSTRUCTION MANUAL

### ■ Function modul BLIND SPOT ASSISTANT - RIGHT

The "**Blind Spot Assistant TASET002**" package for the right side represents the basic package of the CAREYE® SAFETY ANGLE. As a turn assistant, it enables monitoring of the right blind spot.

This represents the system basis and monitors the right lateral area of the vehicle, starting from the front of the vehicle as required, for example, in the traffic sheet of the Federal Ministry of Transport and digitale Infrastructure of the BRD (germany).

The turn assistant is active at a speed of 0 to 30 km/h.

An "information" (yellow display) occurs when a person or a cyclist is detected by the integrated artificial intelligence in the monitored area. This signaling meets the requirements set on the part of BMVI 2018, StV 22/7342-13/10, VkBl. Amtl. Teil Heft 19 2018, Bonn) .

An additional "warning" (red display and warning tone) is given in the event of a moving vehicle (> 0 km/h) and in the event of an imminent collision with a person or a cyclist. The "warning" is only supported if the TASET002 is connected to the CAN and at least the turn signal. Furthermore, the steering angle signal via CAN or via an additional steering angle sensor can still be used for the warning.

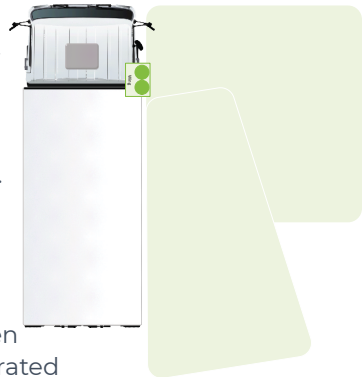

CAREYE® SAFETY ANGLE - TURN-ASSIST  
INSTALLATION AND INSTRUCTION MANUAL

■ Function modul  
Blind spot assistant - right

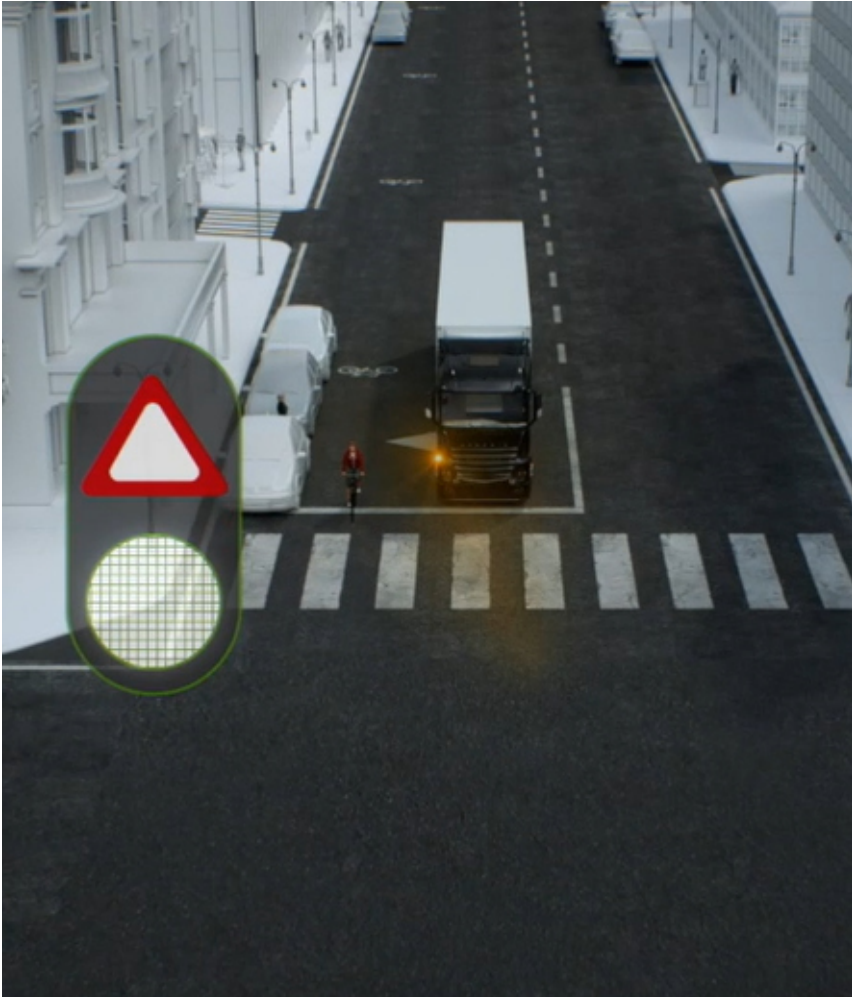

## CAREYE® SAFETY ANGLE - TURN-ASSIST INSTALLATION AND INSTRUCTION MANUAL

### ■ Function module BLIND SPOT ASSISTANT - LEFT - OPTIONAL

The "**Blind Spot Assistant BSS**" package for the left side represents an expansion package or the basic package for vehicles in left-hand traffic. As a turn-off assistant, it enables monitoring of the left blind spot.



This monitors the left lateral area of the vehicle, starting from the front of the vehicle, as required by the Traffic Bulletin of the Federal Ministry of Transport and Digital Infrastructure of the FRG and the UN-ECE proposal for Blind Spot Assist.

Activation is analogous to the "Blind Spot Assistant" for the right.



## CAREYE® SAFETY ANGLE - TURN-ASSIST INSTALLATION AND INSTRUCTION MANUAL

### ■ Function module REAR VIEW ASSISTANT - OPTIONAL

The "**Rear View Assist RFA**" package represents an expansion package of the CAREYE® SAFETY ANGLE.

It enables monitoring of the area behind the vehicle and facilitates maneuvering. The reversing assistant monitors the area up to 9 meters away from the rear of the vehicle. A connection of the TASET002 to the CAN is a prerequisite for the RFA. The RFA becomes active as soon as reverse gear is engaged. If a person or cyclist enters the defined detection area or is already in the zone, this is detected and an information (yellow light signal) is given to the driving personnel. If a person or cyclist is detected in the danger zone, a warning (red light signal + acoustic warning tone) is signaled.

In addition, the image from the rear camera is shown on the monitor.

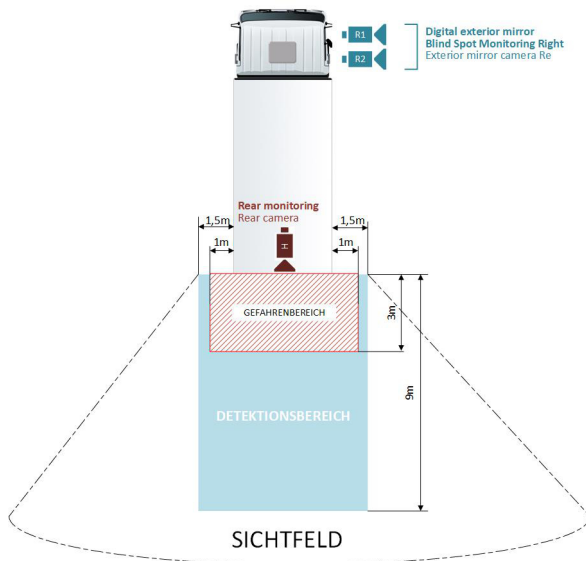

## CAREYE® SAFETY ANGLE - TURN-ASSIST INSTALLATION AND INSTRUCTION MANUAL

### ■ COMPONENTS - OVERVIEW

The CAREYE® SAFETY ANGLE system consists of standard components and additional, optional components and function modules. In the simplest case, the components for installing a right turn assistant consist of:

- 1 TIC box for connecting max. 2 camera sensors, incl. function module for the turn-off assistant on the right as well as the mating connectors for the CAN bus and I/O.
- 1 "Power supply" cable set incl. 2 fuse holders and fuses,
- 1 outdoor camera „Wing“ with 1 or 2 integrated camera sensors,
- Optional: 1 camera extension 90mm for the "Wing",
- Optional: 1 mounting bracket for fastening on the fold of the driver's cab,
- 2 cable sets for "Camera sensor 1" and "Camera sensor 2",
- 1 signal element with integrated sound generator and display element, including permanently mounted connection cable,
- Optional: 1 monitor in 16:9 format, including cable set,
- Optional: 1 steering angle sensor, including cable set,
- the instruction manual



# CAREYE® SAFETY ANGLE - TURN-ASSIST INSTALLATION AND INSTRUCTION MANUAL

## ■ COMPONENTS - TIC BOX

The TIC box is the central element for controlling the system. It provides all the necessary interfaces for connection to the vehicle and the sensors and display elements. The TIC Box is available in two versions with a variable number of connectable camera sensors:

- TIC BOX TATIC-S for 2 or 4 camera sensors

The "Wing" camera has 2 camera sensors.

The TIC box supplies the cameras and the signal elements with the necessary energy - this minimizes the cabling effort. The power is supplied by connecting to the vehicle electrical system. Vehicle electrical systems with 12 VDC to 24 VDC nominal voltage are supported.

Use a fuse circuit of the vehicle or connect the TIC box directly to the vehicle battery. If no fused power supply is available, use the enclosed fuse holders and fuses.

The continuous plus must be fused with 10 AT, the ignition plus with 7.5 AT.

The system is not ready for operation without connecting the TIC box.

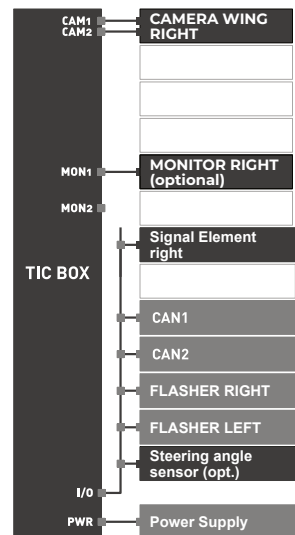

■ COMPONENTS - TIC BOX TATIC-S

TECHNICAL DATA



Description	TIC BOX - central Interface- and Controller Box, TATIC10S-0001 for max. 2 Camera sensors TATIC20S-0001 for max. 4 Camera sensors
Number of camera inputs	2 or 4; digital Inputs for the camera Wing, Fakra 2p, male
Number of monitor outputs	2; digital Outputs, DVI-D, female
Digital switching outputs	8; where 6 are used for the signal element.
Digital switching inputs	4; used for special applications
CAN BUS	CAN1, CAN2, 3p
Ethernet	1; 100/1000 Mbit/s, RJ45
Power supply	12 bis 24 VDC nominal voltage
Power consumption	40 W without cameras, max. 100 W
Environmental conditions	-20°C up to +70°C, humidity between 20% and 80% (non-condensing)
Protection class	IP30
Dimensions	140 x 54.3 x 115 mm (W x H x D), plus mounting bracket W = 174 mm plus ventilation H = 94.3 mm
Weight	~1,000 g, depending on the equipment



# CAREYE® SAFETY ANGLE - TURN-ASSIST INSTALLATION AND INSTRUCTION MANUAL

## ■ Components - TIC BOX TATIC-S

### DIMENSIONS, CONNECTIONS AND DISPLAY ELEMENTS

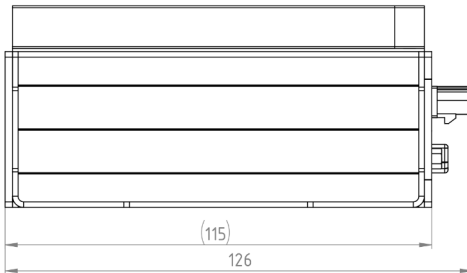
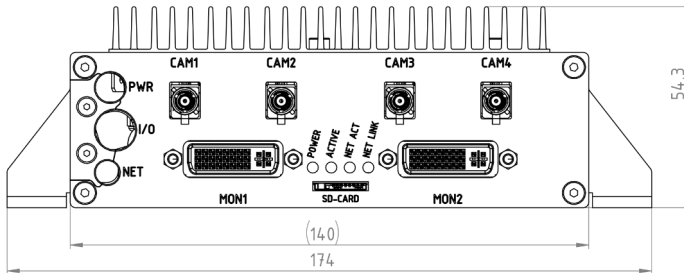

Overall height plus 40 mm for ventilation

POWER	●	TIC Box PowerSupply OK
	○	TIC Box PowerSupply NOT OK
ACTIVE	○	TIC Box faulty
	◐ flashing	Firmware update in progress (fast and regular flashing)
	◑ flashing	Normal operation (slow and short flashing)
	●	TIC Box faulty
NET_ACT	◐ flashing	Data traffic on the network interface
	○	No data traffic
NET_LINK	●	Network cable (NET) plugged in
	○	Network cable (NET) not plugged in

## ■ COMPONENTS - CAMERAS

### GENERAL

CAREYE® SAFETY ANGLE cameras represent the "eyes" of the entire system.

The exterior camera "Wing" is designed to be mounted on the right and left side of the vehicle.

Each Wing is equipped with 1 or 2 camera sensors that provide the required field of view and detection range.

For particularly wide vehicle superstructures, an extended version "Wing long" exterior camera is available, which allows an optimal view of the camera sensors on the endangered areas.

Each camera is heated, enabling reliable operation of the entire system even at low temperatures.

The power supply is provided via the TIC box, thus reducing the installation effort to a minimum.

The following camera models are available for CAREYE® SAFETY ANGLE:

- "Wing" camera right with 1 camera sensor,
- „Wing" camera right with 2 camera sensors,
- "Wing" camera left with 1 camera sensor,
- "Wing" camera left with 2 camera sensors,
- Rear view camera with 1 camera sensor,
- Optional: Camera extension for Wing 90 mm
- Optional: Camera mounting bracket for Wing for mounting on the driver's cab rebate



CAREYE® SAFETY ANGLE - TURN-ASSIST  
INSTALLATION AND INSTRUCTION MANUAL

■ Components - Camera Wing

TECHNICAL DATA



Description	WING - Outdoor camera unit for mounting on the side of the vehicle with 2 camera sensors incl. heating element  TACAM011-R001 1 camera right TACAM012-R001 2 camera right
Number of camera outputs	1/2 digital video outputs for the TIC Box
Optional mounting parts	BG-WING-00260 extension 90 mm BG-WING-00210 Bracket fold mounting
Image sensors	1/2.7" CMOS sensor with 1,920x1,200px, up to 60 fps (depending on operation mode), LFM, AHDR
Power supply	via the TIC box, no own power supply required
Environmental conditions	-40°C up to +70°C
Protection class	IP66/IP67
Dimensions	111 x 80 x 140 mm, (L x H x W), short version; 120 x 90 x 230 mm, (L x H x W), long version; each without sealing lip
Weight	approx. 600 g, short version, approx. 770 g, long version; each without sealing lip and cable



## ■ COMPONENTS - SIGNAL ELEMENT

### TECHNICAL DATA

The signal elements emit optical and acoustic signals, for example when a hazard is detected or as a system message.

Depending on the equipment and the function modules, either only a right signal element or a right and left signal element is used. These are mounted in a clearly visible position, for example on the A-pillar of the vehicle, and are permanently in operation.

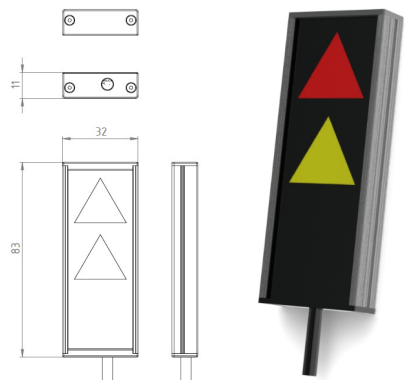

Description	Signal element TASIG301-0001 with buzzer and display element
Buzzer	piezoelectric
Indicator element	bicolor - red and yellow
Power supply	via the TIC box, no own power supply required
Environmental conditions	-40°C up to +85°C
Protection class	IP40
Dimensions	aprox. 32 x 83 x 11 mm (B x H x T), without Kabel
Weight	130 g, incl. cable

## CAREYE® SAFETY ANGLE - TURN-ASSIST INSTALLATION AND INSTRUCTION MANUAL

### ■ COMPONENTS - MONITORS

#### GENERAL

The optionally available CAREYE® SAFETY ANGLE monitors provide a view of the monitored areas, displayed depending on the function package.

The high resolution ensures very good images of what is happening, the high viewing angle ensures excellent readability.

The power supply is provided via the cable set of the TIC box, thus reducing the installation effort to a minimum.

Each monitor is supplied with the necessary cable set for connection to the TIC Box and the power supply.

An adjustable ball head mount or swivel/tilt mount is also available. tilt mount is available for secure mounting of the monitor, for example on the A-pillar.



The installation and operating instructions are part of the "Monitor" scope of delivery.

## CAREYE® SAFETY ANGLE - TURN-ASSIST INSTALLATION AND INSTRUCTION MANUAL

### ■ OPTIONAL - STEERING ANGLE SENSOR

#### GENERAL

The optionally available steering angle sensor from CAREYE® SAFETY ANGLE is used if the warning function with motion prediction is to be implemented on the vehicle and no steering angle sensor is available on the vehicle steering angle sensor is available on the vehicle side or the steering angle is not available or usable on the CAN bus. (described in part M under "Electrical connection")

For proper operation, the steering angle sensor must be the steering angle sensor must be connected to the TIC Box and configured and calibrated in the system.



Application conditions:

- The tilt sensor is used as a steering angle sensor on vehicles with mechanical steering systems (with or without power assist).
- The mechanical steering force transmission must be provided by a steering column lever that can be moved in a vertical plane.
- The tilt sensor must be mounted on the vertically movable steering column lever.
- Application on vehicles with a steering system without a vertically movable pitman arm as well as on horizontally movable components such as steering or track rods is not possible.



The steering angle sensor is suitable for steering column levers that move in a vertical plane. The manufacturer requires clarification with the specialist workshop.

Please also refer to the document Instruction Manual Part M. Operation of the steering angle sensor must be enabled, configured and calibrated on the system side.

## CAREYE® SAFETY ANGLE - TURN-ASSIST INSTALLATION AND INSTRUCTION MANUAL

### ■ Components - Steering angle sensor

#### TECHNICAL DATA

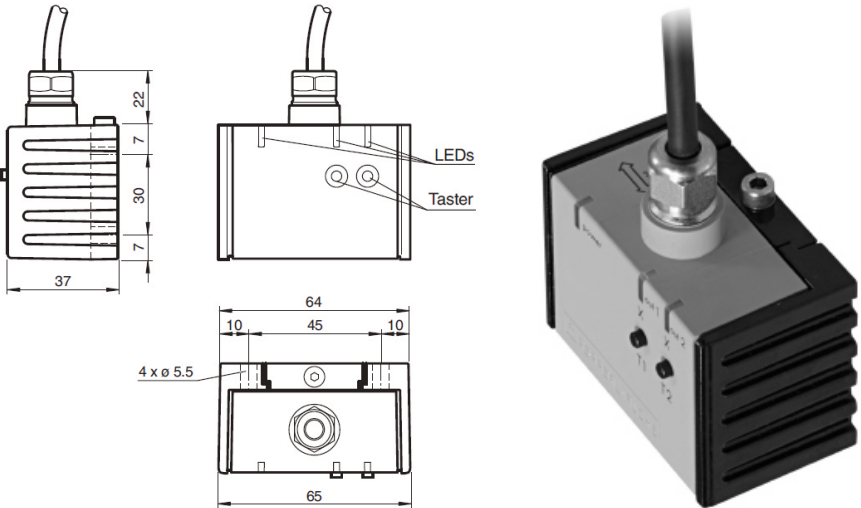

Description	TASEN001-0001
Power Supply	12 up to 24 VDC Nominal voltage
Current consumption	<25 mA in idle mode
Environmental conditions	-40°C up to +85°C
Protection class	IP68/IP69K
Dimensions	44 x 65 x 37 mm (H x B x T), without cable outlet and mounting bracket
Weight	240 g, Without mounting bracket
E1 Type approval	10R-04



# CAREYE® SAFETY ANGLE - TURN-ASSIST INSTALLATION AND INSTRUCTION MANUAL

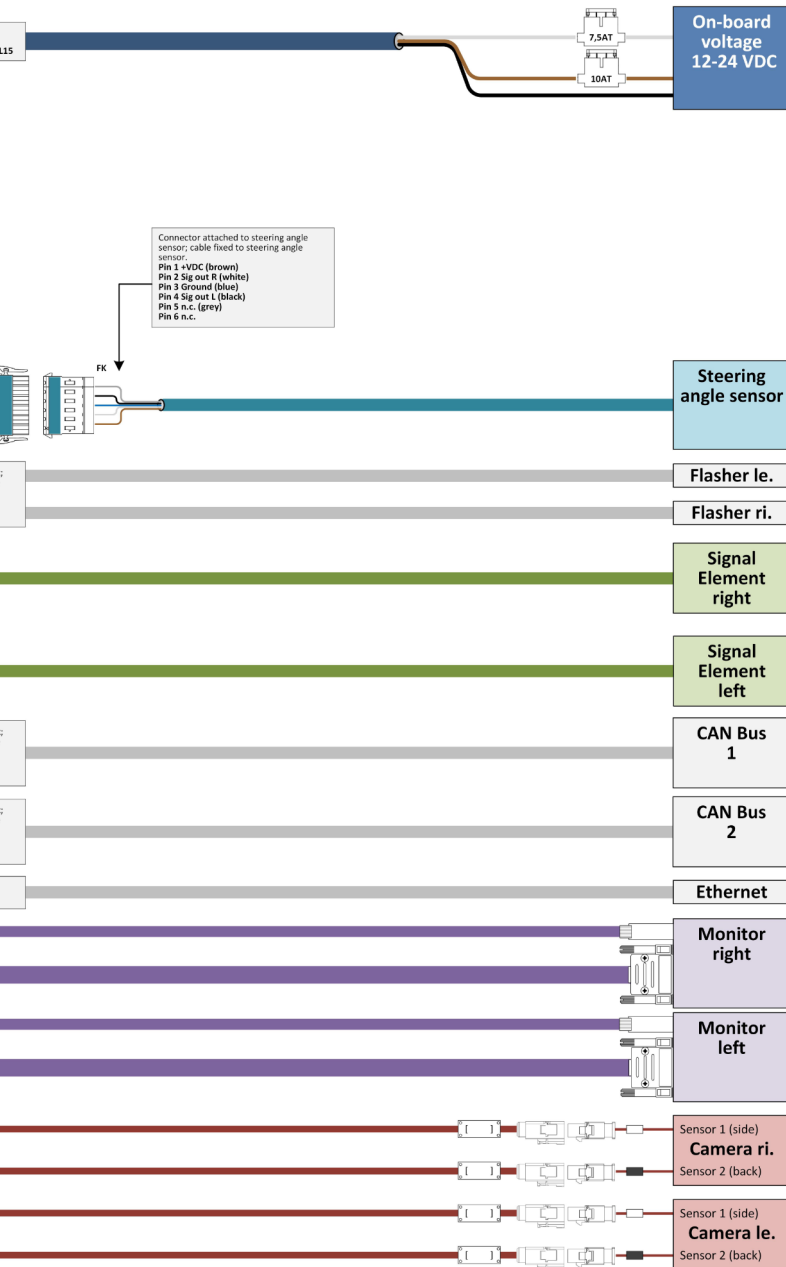

## LEGEND

Scope of delivery TIC Box
Scope of delivery cable set TIC Box
Scope of delivery cameras
Scope of delivery Cordsets Cameras
Scope of delivery steering angle sensor
Scope of delivery signal elements
Scope of delivery monitors
Scope of delivery Cordsets Monitors
not included in delivery

## CAREYE® SAFETY ANGLE - TURN-ASSIST INSTALLATION AND INSTRUCTION MANUAL

### ■ MOUNTING - CAMERA WING

#### CAMERA PARTS

The "Wing" exterior camera is designed to be mounted on the side of the vehicle.

Each Wing is equipped with 2 camera sensors, which provide the required field of view and detection.

The set "Wing" consists of the following parts:

- the camera housing with the two camera sensors [1]
- the adapter housing - only included in the "long" variant [2]
- the console plate [3]
- the sealing lip [4]
- the cable grommet [5]
- the fastening screws and nuts [6]
- the adjustment screws (3x 20 mm and 2x 30 mm) [7]
- the screws for the body of the Wing [8]
- The two camera sensor cables for connection to the connecting cables, which must be ordered separately, each with a length of 5 meters and pre-assembled plug connections. [9]

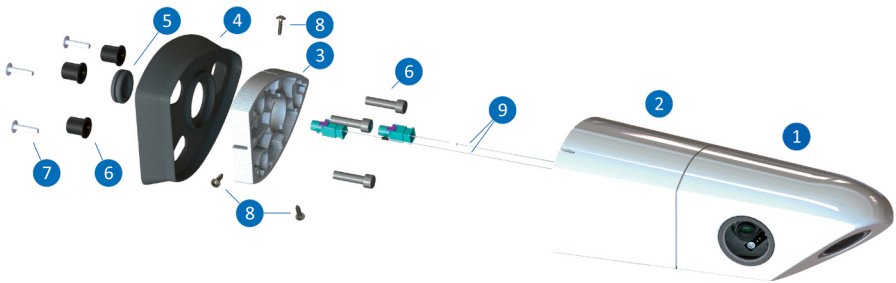

## CAREYE® SAFETY ANGLE - TURN-ASSIST INSTALLATION AND INSTRUCTION MANUAL

### ■ Mounting - Camera Wing

#### MOUNTING CONDITIONS AND LOCATION

Proceed as follows when mounting the camera wing:

##### ■ Determination of the correct mounting position

To determine the correct mounting position of the Camera Wing, it is necessary to observe the area of use.



##### ■ Range of use of the Camera Wing

- Maximum mounting height from floor 3,800 mm
- Minimum mounting height from floor 2,300 mm
- Maximum mounting distance to vehicle front 1,800 mm
- Minimum mounting distance to vehicle front 1,200 mm

Make sure that the wing is horizontal to the ground and 90° to the vehicle axis. The Wing must be mounted in such a way that the mounting position is both within the specified area of use and on a surface that is as level as possible and perpendicular to the road. It is recommended to mount the Wing as high as possible, as this increases the monitoring range and makes the motion prediction more accurate. This reduces the amount of false information. The mounting location is often to be determined individually within the specification, especially for vehicles with superstructures at the rear.

**Therefore, before you drill holes in the outer skin of the vehicle, please check whether the unrestricted view is given. If you have any questions or are unsure, please contact your dealer or EYYES.**

## CAREYE® SAFETY ANGLE - TURN-ASSIST INSTALLATION AND INSTRUCTION MANUAL

### ■ Mounting - Camera Wing

#### MOUNTING OF THE CONSOLE PLATE

The camera wing must be attached to the vehicle in such a way that the specified mounting holes of the console plate for accommodating the wing are in a horizontal line.



Before mounting or drilling into the vehicle, check that both camera sensors can see unobstructed to the rear along the outer edge of the vehicle and that the view is not obstructed by superstructures or attachments. If the view is obstructed, then either the WING extension (Art. No. XXXX) and/or the mounting bracket (Art. No. XXXX) must be ordered additionally from EYYES.

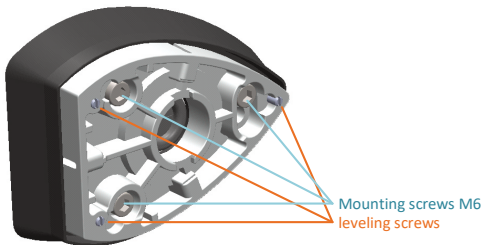
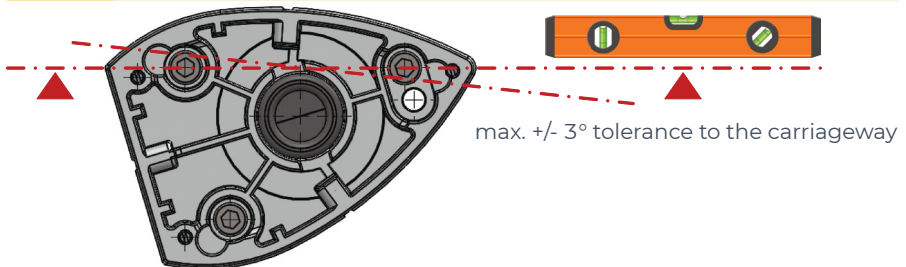

For easy mounting of the console plate [3], you will find a drilling template in the camera set. After drilling the mounting holes and the cable gland, insert the cable grommet [5].

Then place the sealing lip [4] between the vehicle wall and the console plate [3]. Fasten it with the supplied M6 screws and rubber nuts [6]. **Do not tighten the screws yet.**

# CAREYE® SAFETY ANGLE - TURN-ASSIST INSTALLATION AND INSTRUCTION MANUAL

## ■ Mounting - Camera Wing

### DRILLING TEMPLATE

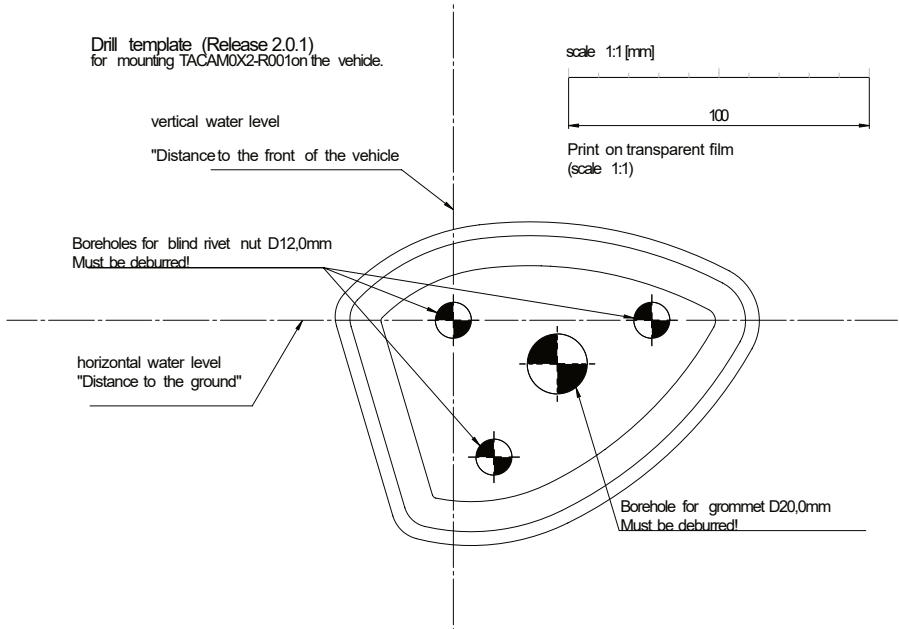

Alternatively, blind rivet nuts can be used instead of the enclosed screws and rubber nuts **[6]**. If required, these must be procured by the workshop; EYYES does not offer these.

In this case, please note that the holes must be drilled with a different diameter according to the blind rivet nuts used.



The illustration is not to scale.  
Use the drilling template included with the camera.

## ■ Mounting - Camera Wing

### SETTING UP THE CONSOLE PLATE

When mounting the console plate, please observe the maximum tolerances indicated in the following figures.

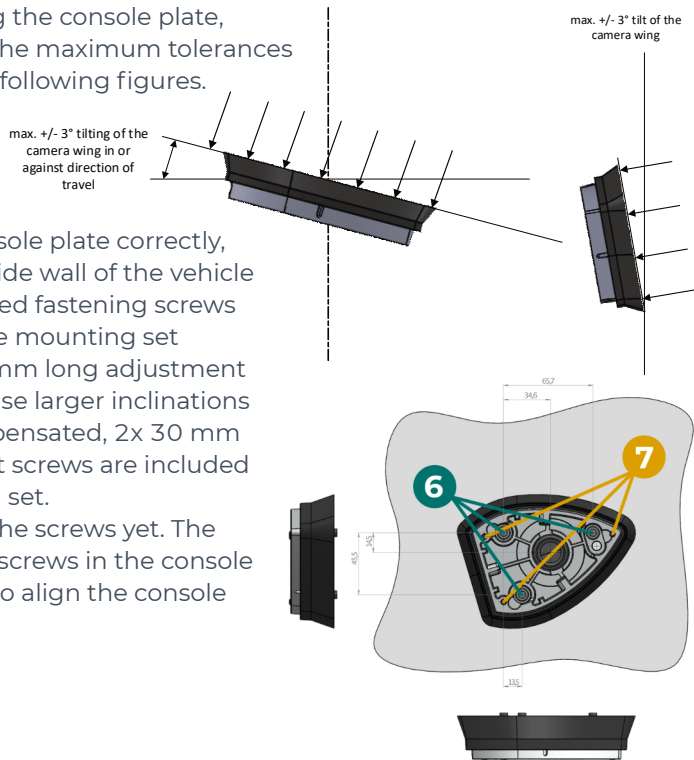

To align the console plate correctly, fasten it to the side wall of the vehicle using the supplied fastening screws and nuts **[6]**. The mounting set includes 3x 20 mm long adjustment screws **[7]**. In case larger inclinations have to be compensated, 2x 30 mm long adjustment screws are included in the mounting set.

Do not tighten the screws yet. The M3 adjustment screws in the console plate allow you to align the console plate exactly.



For the short wing, make sure that the adjustment screws do not protrude from the console plate.

Once this has been done, fix the console plate in the determined end position using a torque wrench by tightening the M6 screws **[6]** with a tightening torque of 5 Nm.



## CAREYE® SAFETY ANGLE - TURN-ASSIST INSTALLATION AND INSTRUCTION MANUAL

### ■ Mounting - Camera Wing

#### MOUNTING THE WINGS

After mounting and aligning the console plate [3], guide the two cables [9] of the wing through the cable grommet [5] into the interior of the carriage. Then place the camera housing [1] on the console plate and fix it to the console plate with the supplied screws for plastics (3.5x12mm) [8].



When placing the camera housing [1] on the sealing lip [4], make sure that the sealing lip completely encloses the edge of the camera housing facing the vehicle on the outside.

Info: When mounting the wing in the specified area of use, the required coverage area - see illustration - is given due to the predefined and unchangeable viewing angles.

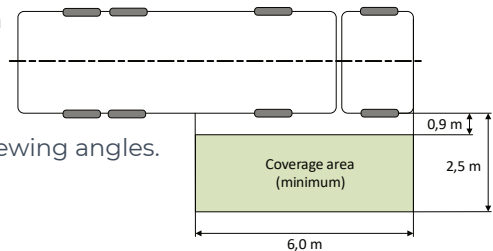

Connect the two sensor cables [9] with the cables to the TIC box. **On the camera side, the sensor of the side camera is marked with a white heat shrink tubing (CAM1), the possible sensor of the rear camera is marked with a black heat shrink tubing (CAM2).**



When laying the cables, take care not to damage them. Protect the cables from sharp edges and corners and do not lay them over them.

After installation, the viewing area can be checked using the optionally available monitor or a standard 16:9 monitor.

## CAREYE® SAFETY ANGLE - TURN-ASSIST INSTALLATION AND INSTRUCTION MANUAL

### ■ MOUNTING - TIC BOX

The TIC Box is designed to be mounted inside the vehicle, it is the central control element of the system.

The following parts are required for mounting the "TIC Box":

- TIC box in the required version, with permanently mounted cable whips for
  - "PWR" power supply,
  - "I/O" for connecting the signal elements, the CAN bus, the steering angle sensor and additional inputs and outputs,
  - "Net" network connection for configuration.
- TATIC cable set for connection to the vehicle electrical system (3-pin),
- Set of mating connectors for the I/Os and the CAN bus,
- this document.

Mount the TIC box horizontally (cooling fins pointing upwards) or vertically in a safe and level area of the interior and screw it on with all 4 screws. Choose such a mounting location so that you can always reach the front of the TIC box and the cable connectors, the cables are not kinked and they cannot be stressed, damaged or unplugged by pulling. Safely accommodate excess lengths of cabling and tie them together with cable ties if necessary.



When connecting, pay attention to electrostatic discharge via the vehicle body, otherwise damage to the electronics may occur during wiring.



The TIC box must be firmly screwed in a dry area and must not be exposed to direct sunlight. Sufficient ventilation must be ensured - covering the TIC box is not permitted. Keep at least 40 mm distance to the cooling fins to avoid overheating due to accumulated heat.



## CAREYE® SAFETY ANGLE - TURN-ASSIST INSTALLATION AND INSTRUCTION MANUAL

### ■ MOUNTING - SIGNAL ELEMENT

The signal element is intended for mounting in the interior of the vehicle, it visually and acoustically signals the detection of a hazard. The following parts are required for mounting the "signal element":

- Signal element with a two-color warning symbol and a loud sound generator with permanently mounted cable and connector.

Mount the signal element in a safe area at the driver's eye level, such as the right A-pillar. Ensure that the warning symbol is clearly visible and the sounder is facing the handlebars.

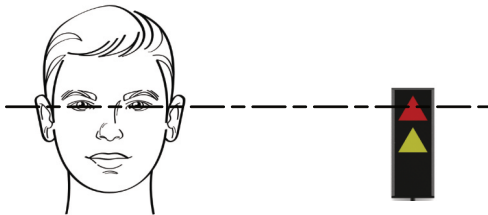

The signal element must never be covered, pasted over or taken out of operation. Make sure that no display or operating elements are covered.

During installation, make sure that any safety devices, such as the airbag, are not impaired by the installation.

When laying the cables, make sure that they are not crushed or otherwise damaged. Protect the cables from sharp edges and corners and do not lay them over them.

WWW.EYYES.COM

## CAREYE® SAFETY ANGLE - TURN-ASSIST INSTALLATION AND INSTRUCTION MANUAL

### ■ MOUNTING - MONITOR



Mounting of the optional monitors is described in the manual of the monitor, which is enclosed with the product.



## CAREYE® SAFETY ANGLE - TURN-ASSIST INSTALLATION AND INSTRUCTION MANUAL

### ■ INSTALLATION - OPTIONAL STEERING ANGLE SENSOR

#### MOUNTING ON THE STEERING COLUMN LEVER

The optional TASEN steering angle sensor is intended for mounting on the steering column lever of the vehicle which moves in the vertical plane. It is not possible to use it on a component that moves in a horizontal plane, such as a steering or track rod. The manufacturer requires clarification with the specialist workshop.

The "Steering angle sensor" set consists of the following parts:

- the steering angle sensor with mounting bracket and fixed cable, which can be shortened if necessary,
- the adapter cable with enclosed mating connector.

The steering angle sensor must be mounted so that the cable outlet runs along the steering column lever, the buttons and display elements must be visible from the outside (see illustration).

Fix the supplied bracket of the steering angle sensor with 2 cable ties or hose clamps suitable for the environmental conditions (outdoor, temperature fluctuations, salt).

The selection of a suitable mounting is the responsibility of the workshop. Guide the cable supply line secured in suitable corrugated tubes or similar to the TIC box. **Fix the supply line accordingly after the calibration process at the latest. During the calibration process, it is advantageous not to fix the TASEN in the holder yet.**



Make sure that the steering angle sensor and its mounting do not collide with other parts. It must not bump anywhere over the entire steering range.

The steering angle sensor on the pitman arm must not slip. Appropriate measures must be taken, especially for tapered steering column levers.

When laying the cable, make sure to provide sufficient excess length and maneuvering areas so that the cable is not strained or loops are created even when the steering is in full lock.

## CAREYE® SAFETY ANGLE - TURN-ASSIST INSTALLATION AND INSTRUCTION MANUAL

### ■ Installation - Steering wheel sensor

#### MOUNTING ON THE STEERING COLUMN LEVER



The cable at the moving points must be free to move, but without being too loose. It must not be able to get caught or hooked, or be taut or under tension. If necessary, shorten the cable to the required length.

The following illustrations show examples of correct assembly.



## CAREYE® SAFETY ANGLE - TURN-ASSIST INSTALLATION AND INSTRUCTION MANUAL

### ■ Installation - Steering angle sensor

#### MOUNTING IN THE BRACKET

The sensor consists of the sensor module and the enclosed mounting bracket. Proceed as follows for mounting:

- Loosen the central screw below the sensor housing [1],
- Push the clamping element back so far that the sensor module [2],
- Now remove the sensor module from the mounting bracket [3],
- Mount the mounting bracket at the intended location,
- reinsert the sensor module [4],
- push the clamping element flush into the mounting bracket [5],
- perform the following step only after calibration, see "Initial calibration": retighten the central screw [6].

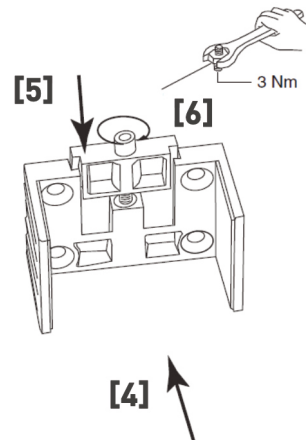
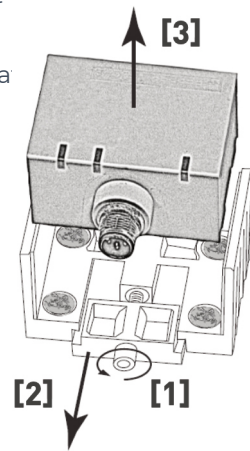

Make sure that you can still loosen or tighten the fastening screw on the bracket of the steering angle sensor after mounting the bracket and the steering angle sensor including cable.

The mounting bracket can also be rotated by 180° for this purpose.

## CAREYE® SAFETY ANGLE - TURN-ASSIST INSTALLATION AND INSTRUCTION MANUAL

### ■ ELECTRICAL CONNECTION

#### GENERAL

- Most cable sets are preconfigured and provided with permanently mounted connectors, do not shorten them:
  - Cable set signal element, an extension cable is optionally available for this,
  - Cable set monitor,
  - Cable set camera.
- The following cable sets can be shortened to the required length:
  - Cable set voltage supply, shortening on the side of the open end,
  - Cable set steering angle sensor, shortening on the side of the open end. The plug connection with spring clips for self-assembly is enclosed.
- The following cable connections must be made during assembly; no cable sets are included for this purpose:
  - Turn signal, if this is not available via the CAN bus. The plug connection with spring terminals is pre-mounted on the side of the TIC box.
  - CAN bus, the plug-in connections with spring terminals for self-assembly are enclosed.



When using the spring terminals, make sure, the correct cable cross-section and that no stranded wires or wires protrude from the body of the connector and that the insulation and that the insulation extends into the connector. Do NOT use wire end ferrules!

The enclosed connectors with spring clamps allow easy assembly without tools. They are designed for a **conductor cross-section of 0.2 to 0.5 mm<sup>2</sup>**.

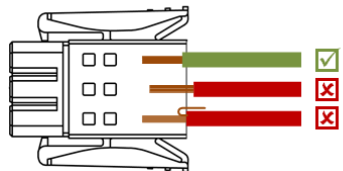

## CAREYE® SAFETY ANGLE - TURN-ASSIST INSTALLATION AND INSTRUCTION MANUAL

### ■ Electrical connection

#### POWER SUPPLY - PWR

- Connect the steady plus, the ignition plus and the ground to the terminals provided for this purpose, but ensure that the voltage is not present at the start of assembly and do not connect the voltage supply until the assembly work has been completed.
- Ensure the supply voltage range with a nominal voltage of 12 VDC to 24 VDC.
- Use the enclosed fuse holders and fuses if no fused circuits are available. The continuous positive must be fused with 10 AT, the ignition positive must be fused with 7.5 AT.



Make sure that the connection to the on-board power supply is correct; if the polarity is reversed, the entire system can be damaged.

The "TATIC cable set" is available for the power supply. This consists of:

- the cable set standard incl. fuse holder and fuses
- the distribution cable, which provides a plug connection for the TIC box, the monitors and the steering angle sensor
- the adapter cable for connecting the two turn signals, if this criterion is not provided via the CAN bus.

# CAREYE® SAFETY ANGLE - TURN-ASSIST INSTALLATION AND INSTRUCTION MANUAL

## ■ Electrical connection

### POWER SUPPLY - PWR

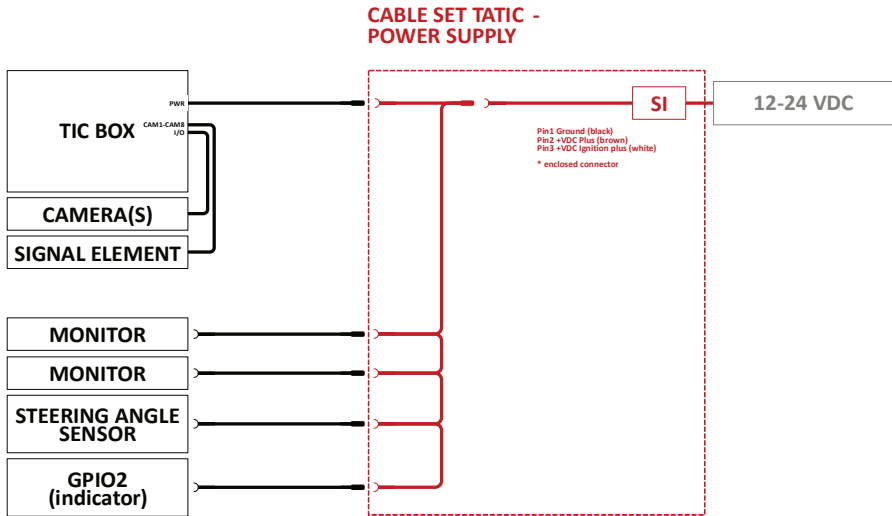

### CAMERAS - CAM

- Connect the camera sensors to the configured CAM-x ports.
- The labeling fields of the camera signal lines allow individual labeling to assign the camera sensors to the correct ports.
- Make sure that the plug connections are firmly engaged.

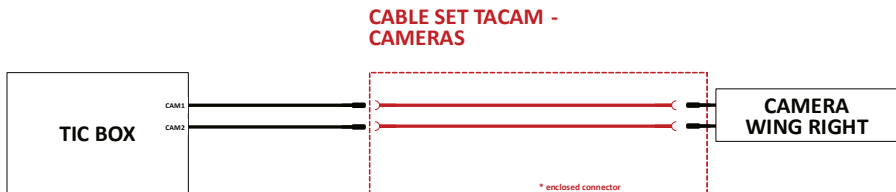

# CAREYE® SAFETY ANGLE - TURN-ASSIST INSTALLATION AND INSTRUCTION MANUAL

## ■ Electrical connection

### SIGNAL ELEMENT - SIG1 AND SIG2

- Connect the signal elements to the configured ports SIG1 and SIG2.
- Make sure that the plug connections are firmly engaged.

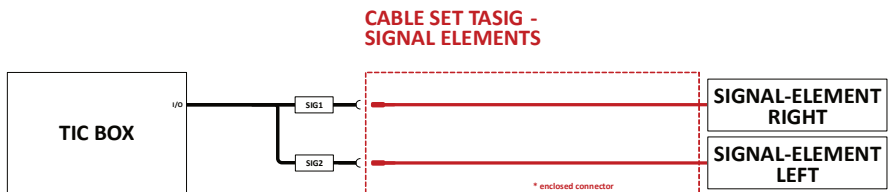

### ETHERNET

- The NET interface is used exclusively for setting in the course of commissioning.  
A laptop or other network-capable device is used for this purpose.  
Use a standard RJ45 8p/8p network cable for the connection.

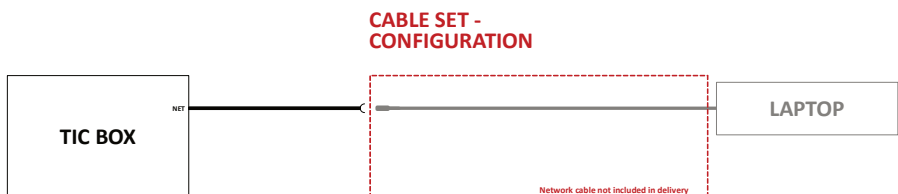

WWW.EYYES.COM

## CAREYE® SAFETY ANGLE - TURN-ASSIST INSTALLATION AND INSTRUCTION MANUAL

### ■ Electrical connection

MONITORS - MON1 AND MON2 (OPTIONAL)



The connection of the optional monitors is described in the manual of the monitor, which is enclosed with the product.

# CAREYE® SAFETY ANGLE - TURN-ASSIST INSTALLATION AND INSTRUCTION MANUAL

## ■ Electrical connection



### OPTIONAL STEERING ANGLE SENSOR

- The cable of the steering angle sensor can be shortened. After shortening, mount the 6-pin connector. The spring clamps enable easy mounting without tools.

PIN	DESCRIPTION	COLOR	CONNECTOR LWS
1	+12 bis 24 VDC	brown	
2	Signal out right	white	
3	Ground	blue	
4	Signal out left	black	
5	Not used	grey	
6	nc	Not connected	



- Connect the steering angle sensor to the "LWS" side of the "GPIO2<->LWS" cable. Connect the "GPIO2" side of the cable to the "GPIO2" interface of the TIC box. Connect the green connector to the power supply cable from the cable set of the TIC box.
- Make sure that the plug connections are firmly engaged.

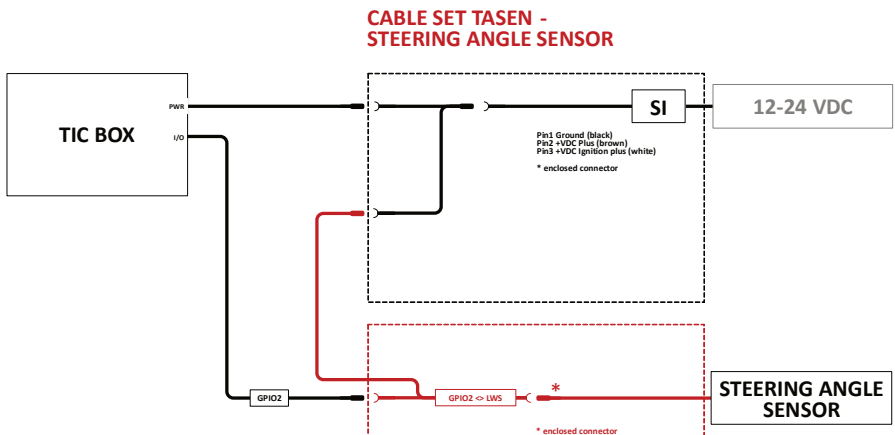

# CAREYE® SAFETY ANGLE - TURN-ASSIST INSTALLATION AND INSTRUCTION MANUAL

## ■ Electrical connection

### INDICATOR (IF NOT AVAILABLE VIA CAN BUS)

- The right **and** left turn signal must be switched on if these criteria are not available on the CAN bus.
- Connect the two criteria to the configured port GPIO1, the permissible levels can be found further on. The connector for this is included in the delivery item of the cable set of the TIC box. The spring clips enable simple mounting without tools.

PIN	DESCRIPTION	COLOR
1	nc	Not connected
2	nc	Not connected
3	INDICATOR right	Cable from client
4	INDICATOR left	Cable from client
5	Ground	black

- Make sure that the plug connections are firmly engaged.

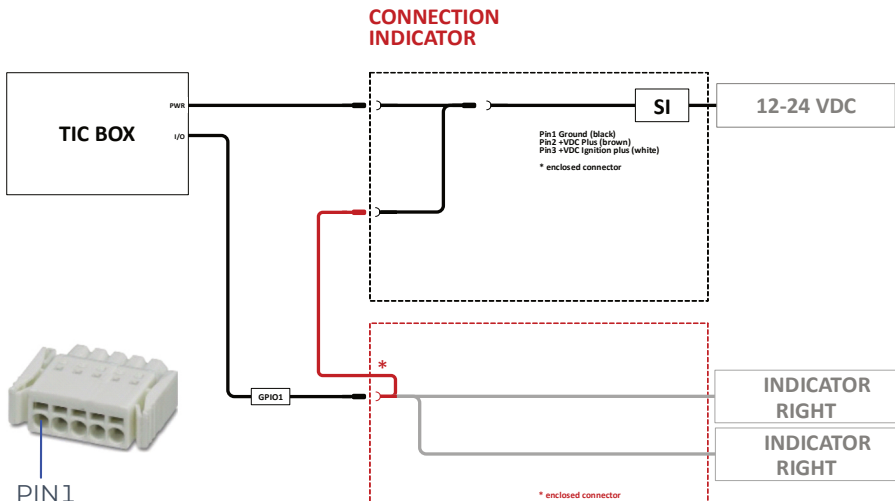

# CAREYE® SAFETY ANGLE - TURN-ASSIST INSTALLATION AND INSTRUCTION MANUAL

## ■ Electrical connection

### CAN BUS

- The CAN bus can be switched on to use the speed-dependent control of the TASET002 and to use the extended collision warning, as the speed signals of the vehicle are available via this.
- The signals "turn signal right" and "turn signal left" as well as the steering angle are available depending on the vehicle equipment.
- If turn signal or steering angle or both criteria are not available, the respective alternative connection variants can be implemented.
- Connect CAN bus 1 to the configured port (CAN bus 2 connection is provided for special projects).
- The connectors for this are included in the delivery of the TIC box. The spring terminals allow easy mounting without tools.

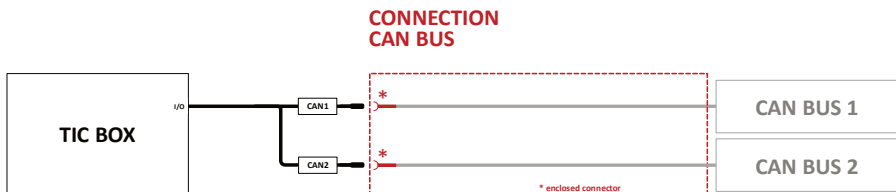

The CAN bus can be installed in the vehicle with different installed in the vehicle. For TASET002, the CAN is configured with 250 kb/s by default. This is especially true for MAN, IVECO, SCANIA etc.. Especially with trucks from Mercedes 500 kb/s are often set on the CAN bus. Alternative Bandwidths can be set via the web server.

## CAREYE® SAFETY ANGLE - TURN-ASSIST INSTALLATION AND INSTRUCTION MANUAL

### ■ Electrical connection

#### CAN BUS

The CAN bus provides the vehicle information required for the system. The following CAN bus signals are required for this:

- Turn Signal Right + Turn Signal Left  
(if not implemented via the direct turn signal tap).
  - PGN 65088 or optionally
  - PGN 65089
- Vehicle Speed  
(must be available and switched on)
  - PGN 65265 - Cruise Control / Vehicle Speed1, or optionally
  - PGN 65132 - Tachograph
- Steering angle Angle, Front Axle Left & Right wheel Speed  
(must be available and switched on if not implemented via the steering angle sensor).
  - PGN 61449 - Vehicle Dynamic Stability Control 2, oder
  - PGN 61469 - Steering Angle Sensor Information, oder
  - PGN 61451 - Electronic Steering Control, oder
  - PGN 65134 - High Resolution Wheel Speed
- Transmission Current Gear (optional)
  - PGN 61445 - Electronic Transmission Controller 2

The assignment and availability of the signals is vehicle-specific and must be specified by the vehicle manufacturer.

The enclosed 3-pole mating connectors **CAN1** and **CAN2** have a conductor cross-section of **0.2 to 0.5 mm<sup>2</sup>** and are to be wired as follows:

PIN	DESCRIPTION
1	CAN High
2	CAN Low
3	CAN Ground

PIN1



# CAREYE® SAFETY ANGLE - TURN-ASSIST INSTALLATION AND INSTRUCTION MANUAL

## ■ Electrical connection

### CAN BUS - CONNECTION VIA INDUCTIVEM CAN CONNECTOR

The CAN Connector can be used instead of direct connection to the CAN bus, in order to tap the CAN bus signals inductively.

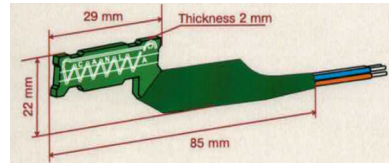

### INSTALLATION

1. enter the CAN connector between CAN-High and CAN-Low. (The CAN connector has a corresponding label).
2. fix the wires with cable ties
3. connect the CAN-Connector with the supplied cable set.

### ANSCHALTUNG

PIN	DESCRIPTION	COLOR
1	CAN High	blue
2	CAN Low	white
3	CAN Ground	GND



In addition to the supplied connector, the CAN connector must be connected to the ignition plus.

DESCRIPTION	COLOR OF THE WIRE FROM CAN CONNECTOR
IGNITION PLUS (KL 15)	orange

# CAREYE® SAFETY ANGLE - TURN-ASSIST INSTALLATION AND INSTRUCTION MANUAL

## ■ Electrical connection

### CAN BUS - CHECK IF SIGNALS ARE PRESENT

To determine whether the CAN bus signals are present, a status test can be performed with the "CAN support tool".

This can be found in the WEBINTERFACE under GPIO/CAN.

Depending on the order variant of the EYES system, different signals must be present:

- "Speed" must **ALWAYS** be present on the CAN

Order variant **WITHOUT steering angle sensor as mounting version:**

- „Steering angle" must be present on the CAN

Order variant with **rear view camera:**

- Gear" must be present at the CAN



If the desired signals are not available, the signal must be searched for on another CAN bus line.

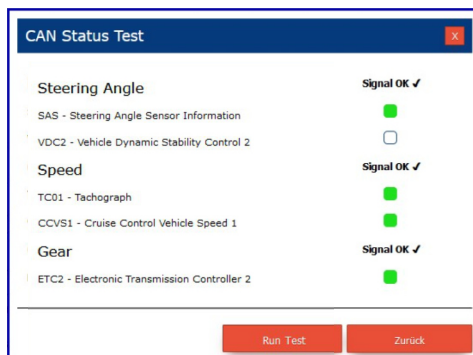



CAREYE® SAFETY ANGLE - TURN-ASSIST  
 INSTALLATION AND INSTRUCTION MANUAL

■ Electrical connection

ALTERNATIVE CONNECTION VARIANTS TO THE CAN BUS

If the criteria BLINKERSIGNAL and/or STEERING ANGLE are not available on the CAN bus, they are read in via the digital input contacts of the interfaces **GPIO1** and **GPIO2**. For this purpose, these must be made available and switched on. The enclosed mating connectors have a conductor cross-section of **0.2 to 0.5 mm<sup>2</sup>**.

PIN	DESCRIPTION	CRITERIA GPIO1
1	nc	Not connected
2	nc	Not connected
3	INDICATOR right	4,5...32 VDC INDICATOR active -0,3...0,8 VDC INDICATOR not active
4	INDICATOR left	4,5...32 VDC INDICATOR active -0,3...0,8 VDC INDICATOR not active
5	Ground	Fahrzeugmasse

PIN	DESCRIPTION	CHRITERIA GPIO2
1	nc	Not connected
2	nc	Not connected
3	Steering angle	-0.3...0.8 VDC Curve radius right from 0...10 meters, 4.5...32 VDC Curve radius right from 10 meters... ∞
4	Steering angle	-0.3...0.8 VDC Curve radius left from 0...10 meters, 4.5...32 VDC Curve radius left from 10 meters... ∞
5	Ground	Vehicle ground

PIN1



## CAREYE® SAFETY ANGLE - TURN-ASSIST INSTALLATION AND INSTRUCTION MANUAL

### ■ Electrical connection

#### IMPORTANT NOTES



The CAREYE® SAFETY ANGLE system or its components must be installed and wired in such a way that they start up automatically when the ignition is switched on. Under no circumstances may the entire system or parts of it be switched off or implemented.



Only use the cables supplied, special lengths are available if required.  
Do not shorten or extend any cables with the exception of the cable for the power supply and the steering angle sensor.

Make sure that the cables are secured against pulling, if necessary tie them together with cable ties to provide strain relief.

Avoid drilling holes with sharp burrs and make sure that the cables do not rub against sharp edges.

When laying the cables, take care not to crush or otherwise damage them.

Protect the cables from sharp edges and corners and do not lay them over them.

Observe the minimum bending radius of the cables and do not go below 7.5 times the outer diameter of each cable.

Do not expose the cabling to heat or aggressive substances such as oils or fuels. Replace defective, damaged or kinked cables immediately.

Operate only the intended and supplied components and devices in the CAREYE® SAFETY ANGLE system.

## CAREYE® SAFETY ANGLE - TURN-ASSIST INSTALLATION AND INSTRUCTION MANUAL

### ■ OPTIONAL STEERING ANGLE SENSOR: INITIAL COMMISSIONING

#### GENERAL NOTES

##### Display and reset

The green Power LED lights up continuously during normal operation, but does not light up during the calibration process; it flashes in the event of undervoltage.

To reset to the factory settings, press the **T1 and T2 keys** simultaneously for >10s.

- After approx. 2s, the **Power LED** goes out, the **LED out 1** and the **LED out 2** start flashing.
- After approx. 10s, the **LED out 1** goes out, the **LED out 2** and the **Power LED** flashes. The reset is then complete.
- The sensor then returns to the normal state, the **Power LED** lights up continuously.

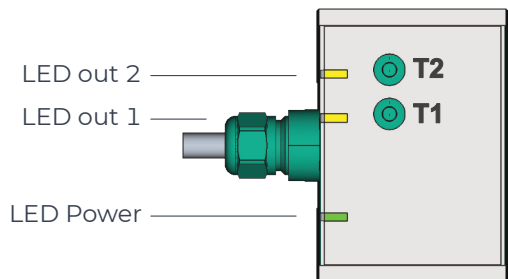

# CAREYE® SAFETY ANGLE - TURN-ASSIST INSTALLATION AND INSTRUCTION MANUAL

## ■ Initial commissioning

### GENERAL NOTES - CALIBRATION

#### Calibration

After proper installation and electrical connection, the steering angle sensor must be calibrated.

Depending on the mounting position of the steering angle sensor - on the **steering column lever outside** (steering angle sensor buttons point to the left side of the vehicle) or on the **steering column lever inside** (steering angle sensor buttons point to the right side of the vehicle) - please perform the calibration procedures described below.

- When **mounting** the steering angle sensor on the **outside** of the pitman arm, follow the steps for calibration in the subchapter **CALIBRATION - MOUNTING ON THE OUTSIDE OF THE STEERING COLUMN LEVER.**
- When **mounting** the steering angle sensor on the **inside** of the pitman arm, follow the steps for calibration in the subchapter **CALIBRATION - MOUNTING ON THE INSIDE OF THE STEERING COLUMN LEVER.**
- The **calibration check** is the same for **both sides** and is described in the subchapters **CHECKING THE CALIBRATION - LEFT CURVE or RIGHT CURVE.**



In any case - i.e. also only when using the turn assistant for the right - the calibration for the right turn must be performed.

## ■ Initial commisioning

### CALIBRATION - MOUNTING ON THE STEERING COLUMN LEVER OUTSIDE

#### Calibration of the right curve

- Put the steering of the vehicle in **neutral position**,
- press the **T2 key** for > 2 seconds,
- Turn the **steering** to the **left as far as it will go**,
- Remove the steering angle sensor from the holder and rotate the sensor further by 45 degrees along the imaginary line,
- then briefly press the **T2 key**,
- To confirm, the **LED out 2** lights up for about 1.5 seconds, then it flashes again
- reinsert the steering angle sensor into the holder.
- bring the steering of the vehicle into **neutral position**,
- Turn the **steering wheel approx. one (1) turn to the right**. The curve radius thus described must not be less than 10 meters!
- Then briefly press the **T2 key**,
- to confirm, the **LED out 2** lights up for about 1.5 seconds, then it changes to normal operation (lights up outside the curve radius, does not light up within curve radius),

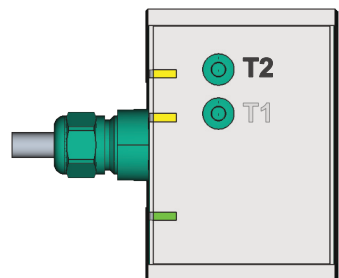

## CAREYE® SAFETY ANGLE - TURN-ASSIST INSTALLATION AND INSTRUCTION MANUAL

### ■ Initial commisioning

#### CALIBRATION - MOUNTING ON THE STEERING COLUMN LEVER INSIDE

##### Calibration of the right curve

- Put the steering of the vehicle in **neutral position**,
- press the **T2 key** for > 2 seconds,
- Turn the **steering wheel approx. one (1) turn to the right**. The curve radius thus described must not be less than 10 meters!
- then briefly press the **T2 key**,
- To confirm, **LED out 2** lights up for about 1.5 seconds, then flashes again,
- bring the steering of the vehicle into **neutral position**,
- Turn the **steering** to the **left as far as it will go**,
- Remove the steering angle sensor from the holder and rotate the sensor further by 45 degrees along the imaginary line,
- Then briefly press the **T2 key**,
- to confirm, the **LED out 2** lights up for about 1.5 seconds, then it changes to normal operation (lights up outside the curve radius, does not light up inside the curve radius).
- reinsert the steering angle sensor into the holder,

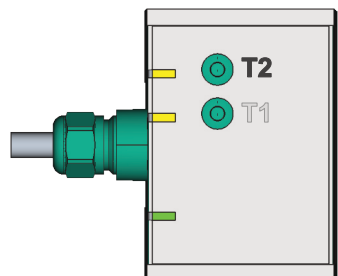

## ■ Initial commisioning

### CHECKING THE CALIBRATION - RIGHT CURVE

- Move the steering to the **neutral position**.  
The **LED out 1** and **LED out 2** light up.

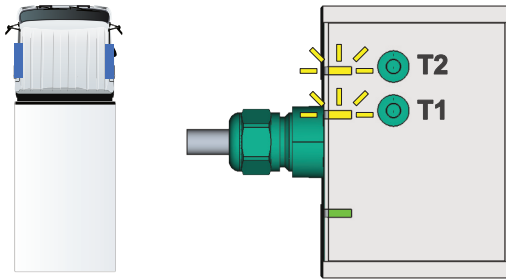

- Slowly turn the **steering to the right as far as it will go**.
- As the steering angle increases, the curve radius becomes smaller.
- The **LED out 2** must go out at the latest when the curve radius on the right falls below 10 meters.
- The **LED out 1** is not relevant for this process (goes out in the course of the in the course of the steering input)

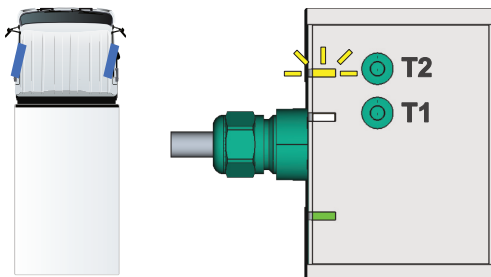

# CAREYE® SAFETY ANGLE - TURN-ASSIST INSTALLATION AND INSTRUCTION MANUAL

## ■ CONFIGURATION

### WEBINTERFACE

A web interface enables the setting of various functions and parameters. The possibilities are determined by the specific firmware and can therefore vary.

To be able to make settings, you need

- a network-compatible laptop and
- a standard RJ45 network cable of appropriate length.

Change the IPv4 network address of the laptop to an address in the range **192.168.134.x**, e.g. 192.168.134.100, the subnet mask is **255.255.255.0**. A gateway is not used, disable it or leave this field empty.

Use the network cable to connect the laptop to the TIC box (labeled "NET").

Now start a web browser to establish a connection to the TIC Box. For this purpose, please use a current browser in the latest version (such as Firefox, Chrome, Edge or Safari), **MS Internet Explorer is NOT supported**.

The network address of the TIC box is **http://192.168.134.123**, enter this address in the address field of the browser to access it.

The subsequent dialog prompts you to enter the user name and password. The user is **customer**, the password is also **customer**.

Authentifizierung erforderlich - Mozilla Firefox

http://192.168.134.123 verlangt einen Benutzernamen und ein Passwort. Ausgabe der Website: "EYES CSA Webinterface"

Benutzername: customer

Passwort: ●●●●●●●

OK Abbrechen



If the connection cannot be established, restart the box and try again. box and try to establish the connection again. again.

# CAREYE® SAFETY ANGLE - TURN-ASSIST INSTALLATION AND INSTRUCTION MANUAL

## ■ Configuration

### WEBINTERFACE - VEHICLE DATA

Depending on the available functions, several tabs are available, you can select them horizontally at the top of the window.

In the "**VEHICLE**" tab, you must enter the vehicle data to assign the control box to this particular vehicle.

For the correct use of the steering angle information via CAN bus, the following fields must be entered:

- Track width (distance between left and right front tires [cm])
- Wheelbase (distance between front and rear axle [cm])
- Turning circle (diameter [cm])
- Steering wheel angle (in degrees)
- with current value display and button to accept [degrees]

**Vehicle**

Manufacturer

Model

Description

VIN

Registration

**Dimensions**

Wheelbase  cm

Turning Circle  cm

Max Steering Wheel Angle  Degree

Current Steering Wheel Angle  Degree

© EYES GmbH 2021 english

**i** When using the steering angle via CAN, the information must be entered on this tab, otherwise the calculation from the CAN data will be incorrect.



# CAREYE® SAFETY ANGLE - TURN-ASSIST INSTALLATION AND INSTRUCTION MANUAL

## ■ Configuration

### WEBINTERFACE - GPIO/CAN

In the "**GPIO/CAN**" tab you can

- test the signal element (yellow/red display, acoustic warning),
- adjust the **data rate/baud rate** of the CAN bus (250 kb/s or 500 kb/s).
- check the proper function of the sensor data of the turn signals and the steering angle sensor.
- The Individual speed message.
- Perform the **CAN status test**

**Signaling Test**

Warning

Information

Buzzer

**CAN Settings - Input 1**

Baud Rate

Protocol Version

**CAN - Custom Speed Message**

Settings  Active

PCN ID

Data Byte Count

Byte Settings

Division Factor

**CAN Support**

Open Test...

**Result**

Steering Wheel Angle

Speed

Gear

**Status**

Indicator right

Indicator left

Steering angle sensor

Gear



Without the correct setting of the data rate/baud rate, no information can be processed by the CAN bus.

# CAREYE® SAFETY ANGLE - TURN-ASSIST INSTALLATION AND INSTRUCTION MANUAL

## ■ Configuration

### WEBINTERFACE - GPIO/CAN - CAN STATUS TEST

With the CAN support it is possible to check whether the desired CAN bus signals are present on the corresponding line.

The CAN bus must be connected for the check. The check can be started via "Start test".

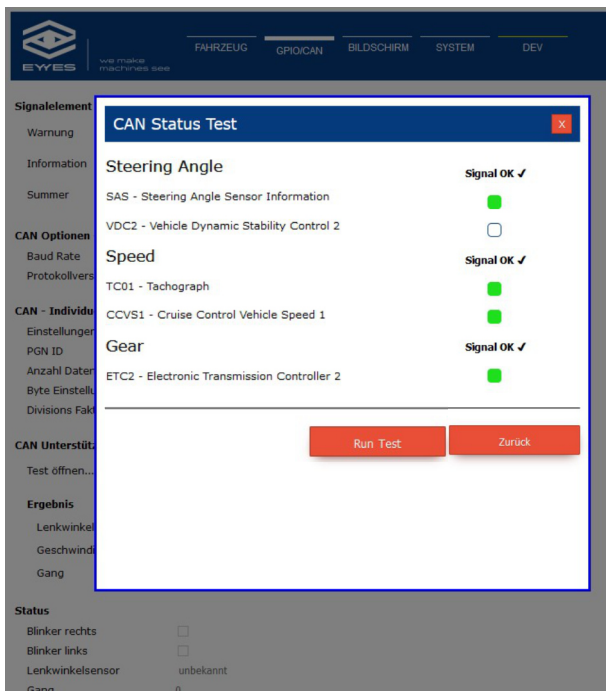

**i** If the desired signals are not available, the signal must be searched for on another CAN bus line.



# CAREYE® SAFETY ANGLE - TURN-ASSIST INSTALLATION AND INSTRUCTION MANUAL

## ■ Configuration

### WEBINTERFACE - SCREEN

In the "**SCREEN**" tab, the "Wing Type" must be entered depending on the configuration ordered. The possibilities consist of:

- TACAM022 - long wing, two cameras
- TACAM012 - short wing, two cameras
- TACAM021 - long wing, one camera
- TACAM011 - short wing, one camera

In addition to that

- Select the configuration for the presence of the **rear view camera**.
- Set the **image composition** (depending on the existing wing) and **rotate** or **mirror** it.

The screenshot shows the CAREYE web interface configuration page for the SCREEN tab. The page is divided into several sections:

- Camera Options:**
  - Blind Spot Assistant: TACAM011 - one camera
  - Rear View Assistant: None
- Image Layout Settings:**
  - Blind Spot Assistant:**
    - 1 Image:** A single box labeled CAM 1.  Select
    - 2 Images:** Two boxes, one labeled CAM 2 above CAM 1.  Select
  - Settings:**

CAM	Mirrored	Flipped	Rotation
CAM 1	<input checked="" type="checkbox"/>	<input type="checkbox"/>	90°
CAM 2	<input type="checkbox"/>	<input checked="" type="checkbox"/>	0°

At the bottom right of the configuration area, there are two buttons: "Save" and "X".

At the bottom of the page, there is a footer: "© EYES GmbH 2021" and a language selector set to "english".

After settings on these pages, the TIC box **MUST** be restarted.

# CAREYE® SAFETY ANGLE - TURN-ASSIST INSTALLATION AND INSTRUCTION MANUAL

## ■ OPERATION AND USE

### SYSTEM READINESS FOR OPERATION

The system does not have any setting options in operational mode. When the vehicle is started or the ignition is switched on, the entire CAREYE® SAFETY ANGLE system starts up automatically and is ready for operation. The system cannot be deactivated or adjusted by the operator; it is always in operation.

The readiness for operation after the system has been started up is indicated as follows on all connected signal elements and monitors:

- by the permanently lit green POWER LED on the front of the TIC BOX,
- by the ACTIVE LED on the front of the TIC BOX flashing green briefly and permanently,
- by three short beeps of the signal elements in rapid succession,
- by three short flashes of the yellow and red warning indicators,
- the optional monitors show a picture.

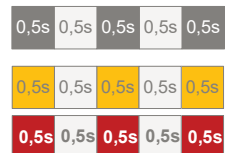

If the system is not ready for operation - i.e. during commissioning or operation - an error signal is generated:

- no or deviating display of the POWER LED and/or ACTIVE LED on the front of the TIC BOX,
- by a continuous tone of the signal element for 5 seconds,
- by continuous illumination of the yellow warning indicator,
- in case of visual impairment, e.g. falling below the minimum ambient illumination of 15lx, only the yellow LED lights up, no warning tone is emitted.

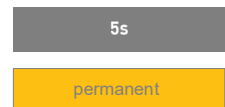

# CAREYE® SAFETY ANGLE - TURN-ASSIST INSTALLATION AND INSTRUCTION MANUAL

## ■ Operation and use

### VERIFICATION OF FUNCTIONALITY

During operation, the proper function of the system is continuously checked.

If the system is functional, the information signal (= yellow flashing) indicates when a person or a cyclist is in the danger zone.

If the system is connected to CAN bus 1 and the vehicle has a steering angle sensor or if the turn signal is connected, a collision warning (= red flashing and acoustic warning tone) is output at speeds > 0 km/h and < 30 km/h if a cyclist with a risk of collision approaches from the side or from behind.





If two signal elements are installed, the previously described messages are output on the respective assigned signal elements (left/right).



## ■ Operation and use

### TURN ASSIST RIGHT

Monitoring area	right
Speed	0 up to 30 km/h
Direction	forward
Signal element right optical information yellow flashing	upon detection of an object within the monitored area 
Signal element right optical warning red flashing	When an object is detected within the monitored area and there is a risk of collision (sequence duration can be set) 
Signal element right acoustic warning	When an object is detected within the monitored area and there is a risk of collision (sequence duration can be set) 
Monitor right red marking	When an object is detected within the monitored area and danger of collision the object is framed in red.



For the detection of cornering, the direction of travel and the set turn signal, the respective required and switched-on CAN bus signal is necessary. Alternatively, these criteria can also be read in and processed as digital input signals. The optical and acoustic warning signals are output continuously during the hazardous situation.

# CAREYE® SAFETY ANGLE

Operation and use

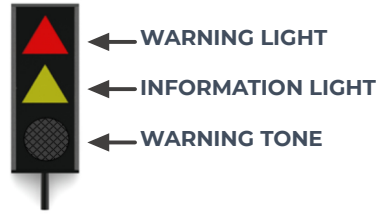

## SYSTEM ACTIVE UP TO 30 KM/H



START OF THE SYSTEM



ACTIVATION OF THE WARNING FUNCTION  
(WHEN THE INDICATOR IS ACTIVATED OR  
WHEN THE STEERING IS TURNED)

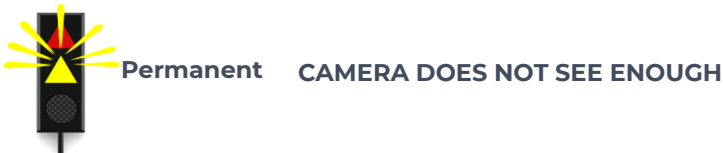
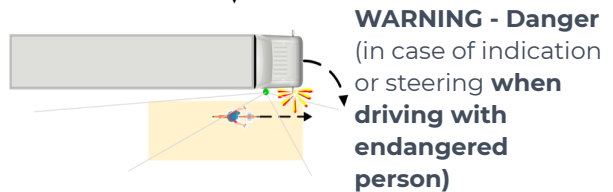
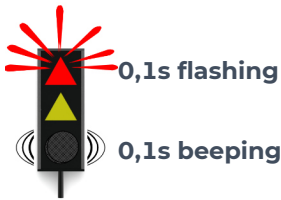
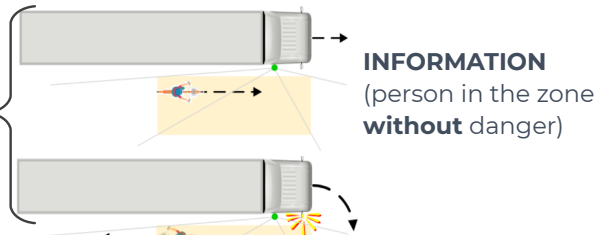
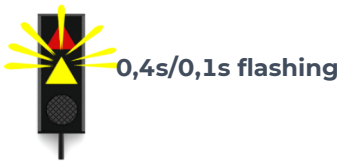

# CAREYE® SAFETY ANGLE - TURN-ASSIST INSTALLATION AND INSTRUCTION MANUAL

## ■ Operation and use

### MONITOR - TURN ASSIST RIGHT (OPTIONAL)

The system does not have any setting options in operational mode. When the vehicle is started or the ignition is switched on, the entire CAREYE® SAFETY ANGLE system starts up automatically and is ready for operation.

The system cannot be deactivated or adjusted by the driver, it is always in operation.

Monitoring area	right
Criteria	Detected cornering on the right up to a radius of 10 meters OR set right turn signal.
Speed	0 up to 30 km/h
Direction	forward
Monitor left yellow frame	Detection active, nichts detected
Monitor right orange frame	Detection active, object NOT detected
Monitor right no frame	Detection not active

The monitor shows the images of both camera sensors of the Wing.

These images are split in the ratio 1/3 (rear camera sensor) and 2/3 (side camera sensor).

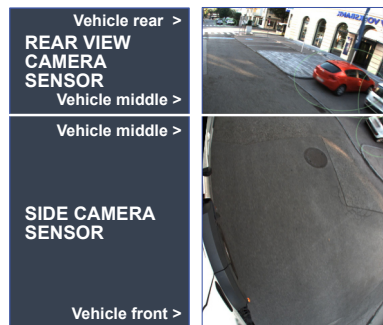

## CAREYE® SAFETY ANGLE - TURN-ASSIST INSTALLATION AND INSTRUCTION MANUAL

### ■ SYSTEM CHECK AND TROUBLESHOOTING

Regularly check the functionality of the system:

- Test the function of the detection by simulating the typical situation in road traffic including a turn and the use of the turn signal,
- Check the functionality of the signal generator (3x signal tone and flashing at system start),
- Check the functionality of the monitor and its image quality,
- Pay attention to the tightness of the camera by visual inspection. Check whether water has penetrated,
- Regularly clean the camera's viewing windows using a soft cloth,
- Check the cables for chafing.

Information on troubleshooting can be found in the FAQ section at <https://www.abbiegeassistent.at/faq-csa>.



CAREYE® SAFETY ANGLE - TURN-ASSIST  
 INSTALLATION AND INSTRUCTION MANUAL

■ PARTS OVERVIEW

TIC BOX - 2 SENSORS

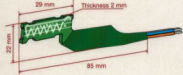
	DESCRIPTION	FIGURE
	<b>SET TIC Box TATIC10S-0001-xx - 2 Sensors</b>	
	TIC Box incl. cable whip, max. 2 camera sensors (1)	
	Function module turn assistant right (1)	
	Accessory bag with mating connector GPIO (2) and CAN bus (2)	
	Installation and instruction manual part M (1)	
	<b>SET TIC Box Cable set power supply TACAB001-0020-xx</b>	
	Cable set standard, 200 cm (1)	
	Accessory bag with distributor cable monitor, steering angle sensor and GPIO1 (1) and adapter cable turn signal via GPIO (1)	
	Accessory bag with fuse holders (2) and fuses (2)	
	<b>SET CAN INDUKTIV CONNECTOR TASEN002-0001-XX</b>	
	Induktiver CAN-Bus Abnehmer inkl. Kabel [1]	



# CAREYE® SAFETY ANGLE - TURN-ASSIST INSTALLATION AND INSTRUCTION MANUAL

## ■ Parts overview

### TIC BOX - 4 SENSORS

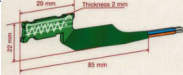

DESCRIPTION	FIGURE
<b>SET TIC Box TATIC20S-0001-xx - 4 Sensors</b>	
TIC Box incl. cable whip, max. 4 camera sensors (1)	
Function module turn assistant right (1)	
Accessory bag with mating connector GPIO (2) and CAN bus (2)	
Installation and instruction manual part M (1)	
<b>SET TIC Box cable set power supply TACAB001-0020-xx</b>	
Cable set standard, 200 cm (1)	
Accessory bag with distributor cable monitor, steering angle sensor and GPIO1 (1) and adapter cable turn signal via GPIO (1)	
Accessory bag with fuse holders (2) and fuses (2)	
<b>SET CAN INDUKTIV CONNECTOR TASEN002-0001-XX</b>	
Induktiver CAN-Bus Abnehmer inkl. Kabel [1]	



CAREYE® SAFETY ANGLE - TURN-ASSIST  
 INSTALLATION AND INSTRUCTION MANUAL

■ Parts overview

CAMERAS

DESCRIPTION	FIGURE
<b>SET camera TACAM011-R001-xx - right short</b>	
Camera Wing with 1 camera sensors; right, short (1)	
Accessories bag with sealing lip small (1)	
Accessory bag with mounting kit (1)	
Drilling template (1)	
<b>SET camera TACAM012-R001-xx - right long</b>	
Camera Wing with 2 camera sensors; right, long (1)	
Accessories bag with sealing lip large (1)	
Accessory bag with mounting kit (1)	
Drilling template (1)	
<b>SET camera cable set TACAB002-0050-xx</b>	
Cable set standard, 500 cm (for one camera sensor, 2 cable sets are required per camera wing)	



CAREYE® SAFETY ANGLE - TURN-ASSIST  
 INSTALLATION AND INSTRUCTION MANUAL

■ Parts overview

SIGNAL ELEMENT

DESCRIPTION	FIGURE
<p>SET Signal element TASIG301-0001-xx</p> <p>combined optical/acoustic signal element, incl. permanently connected cable set 300 cm (1)</p>	
<p>Accessory bag with mounting bracket and screws (1)</p>	



CAREYE® SAFETY ANGLE - TURN-ASSIST  
 INSTALLATION AND INSTRUCTION MANUAL

■ Parts overview

MONITORS



ARTICLE-NR.	DESCRIPTION	FIGURE
CS-SET-0017x	<b>SET Monitor TAMON100-0001-xx 16:9, 10"</b> Surface monitor format 16:9, diagonal 10" (1)	
BT-DOC-0023x	Installation manual part D (1)	
	<b>SET Monitor TAMON070-0001-xx 16:9, 7"</b> Aufbaumonitor Format 16:9, Diagonale 7" (1)	
	Monitormontage-Halterung	
	Montagehandbuch Teil D (1)	
CS-SET-0018x	<b>SET Monitor cable set VIDEO TACAB007-0030-xx</b> Cable set video signal for TAMON100-0001-xx 300 cm (1)	
CS-SET-0019x	<b>SET Monitor cable set POWER TACAB008-0030-xx</b> Cable set Power for TAMON100-0001-xx, 300 cm (1)	



CAREYE® SAFETY ANGLE - TURN-ASSIST  
 INSTALLATION AND INSTRUCTION MANUAL

■ Parts overview

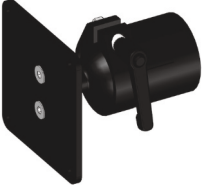
MONITORS - ACCESSORIES

ARTICLE-NR.	DESCRIPTION	FIGURE
CS-SET-0012x	<p><b>Kugelkopfhalterung TAACC001-0001-xx</b></p> <p>Ball head mount for 16:9 surface monitors</p>	
CS-SET-0013x	<p><b>Pan/Tilt mount TAACC001-0002-xx</b></p> <p>Pan/tilt mount for 16:9 surface monitors</p>	



## ■ Parts overview

### STEERING ANGLE SENSOR

	DESCRIPTION	FIGURE
	<b>Steering angle sensor TASEN001-0001-xx</b> Steering angle sensor with fixed cable 700 cm	 A black rectangular electronic sensor unit with a silver metal mounting bracket on top. A black cable is connected to the top of the bracket. The unit has several horizontal ridges on its side and a small circular port on the front face.
	Accessory bag with adapter cable and mating connector Steering angle sensor (1)	
	Installation manual part L (1)	



## ■ GENERAL INFORMATION

### SYSTEM LIMITS

The turn-off assistant has been tested on the basis of legal requirements. Please bear in mind that, despite the sophisticated technology, this is an assistance system and must be used as such.

If visibility conditions are such that safe driving is not possible - for example fog, heavy rain or snowfall - this can affect the function of the system.

In addition, the cameras or the protective camera glass on them must be cleaned of dirt.

Objects outside the field of view cannot be detected by the system. If there is extraneous glare, e.g. from a vehicle approaching from behind, object detection can be delayed or disturbed. In the case of very small or thin objects such as strings, ribbons or wires - especially with a color-like background - object detection may be delayed or the object may not be detected.

### STORAGE AND DISPOSAL OF THE PACKAGING

Store the in the components only in the original and, if possible, closed boxes of the delivery.

The recommended storage temperature is between 19° and 23°C, humidity 45-65%.

Protect the components from liquids, shock-like temperature changes, intense sunlight, dust, aggressive atmosphere and mechanical impact. Do not store the components in the direct area of a heating fan.

Shelf life of corrugated cardboard is one (1) year under good environmental conditions. Avoid stacking the boxes during storage. **There is a danger of cutting at the edges of the corrugated board!**

The material of the packaging is recyclable, use the area-wide systems for disposal.

# CAREYE® SAFETY ANGLE - TURN-ASSIST INSTALLATION AND INSTRUCTION MANUAL

## ■ General Information

### DISPOSAL

The correct collection of defective components enables valuable raw materials to be recycled. Therefore, observe the relevant and national regulations for the disposal of electronic waste; do not dispose of it in the residual waste under any circumstances.

### ABOUT THIS DOCUMENT

This document has been prepared with the greatest possible care; however, due to continuous further development, information may no longer correspond to the current development status of the products. EYYES GmbH reserves the right to change the information without prior notice. EYYES GmbH assumes no liability for incidental or consequential damages resulting from the use of this document. EYYES GmbH retains the copyright to this document, which may not be reproduced without prior written permission from EYYES GmbH.

### TERMS OF BUSINESS

Our General Terms and Conditions apply to these products:  
<https://www.abbiegeassistent.at/agbs-produktlieferungen>

### E-MARK



ABE NUMBER

**KBA91877**

---

## **EYYES GmbH**

Im Wirtschaftspark 4  
3494 Gedersdorf  
Österreich

[office@eyyes.com](mailto:office@eyyes.com)  
[www.eyyes.com](http://www.eyyes.com)